

Инструкция по установке **HYUNDAI CRETA**

(2016-2021; 2021-)

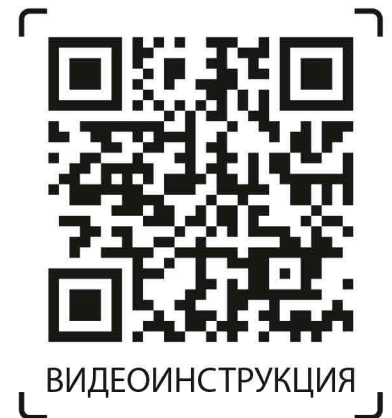

Арт.: F.2312.002

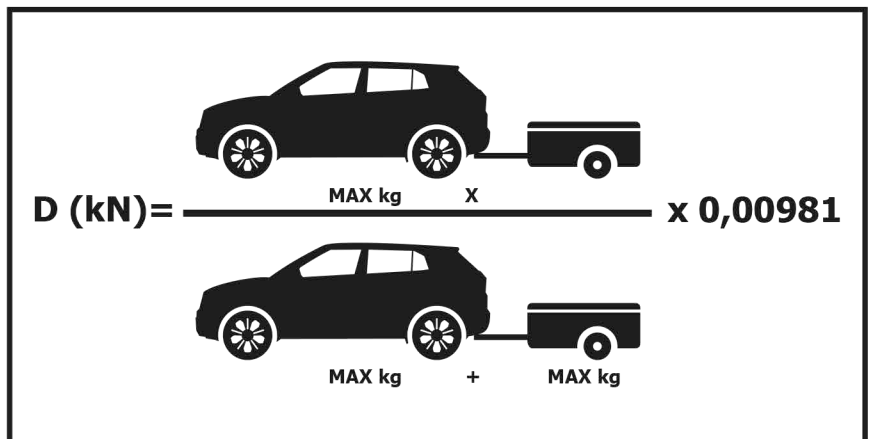
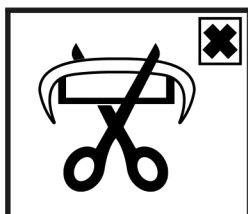
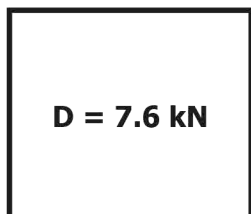
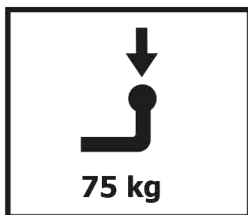
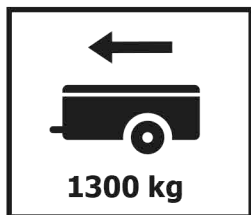

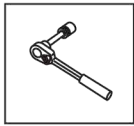

Вкрутить/выкрутить используя инструмент

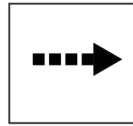

Движение

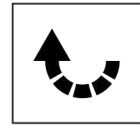

Поворот



Вкрутить/выкрутить не затягивая

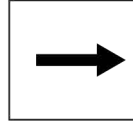





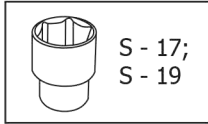
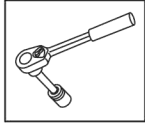



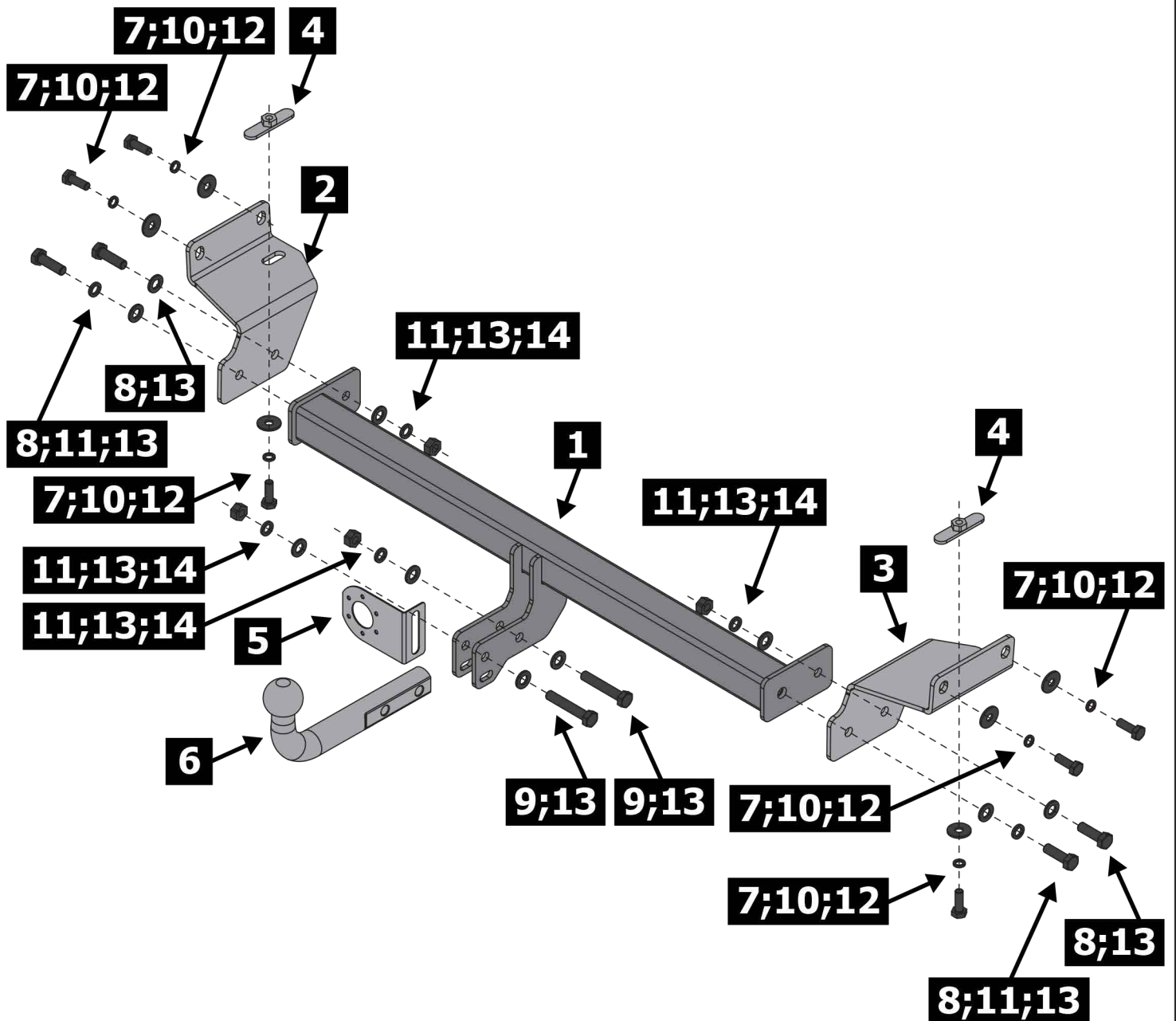

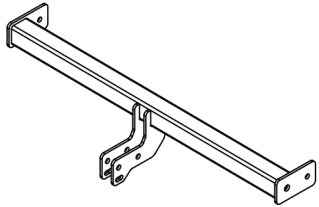
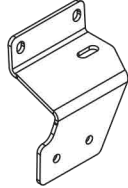
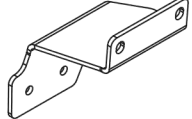
Расположение

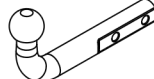
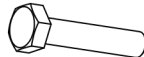
Используемый инструмент:



S - 17;
S - 19



1	x1	Балка	
2	x1	Кронштейн левый	
3	x1	Кронштейн правый	
4	x2	Закладная гайка	
5	x1	Подрозетник	
6	x1	Крюк	
7	x6	M10x1.25x30	
8	x4	M12x1.25x40	
9	x2	M12x1.25x70	
10	x6	∅ 10	
11	x6	∅ 12	
12	x6	∅ 10	
13	x10	∅ 12	
14	x4	M12x1.25	

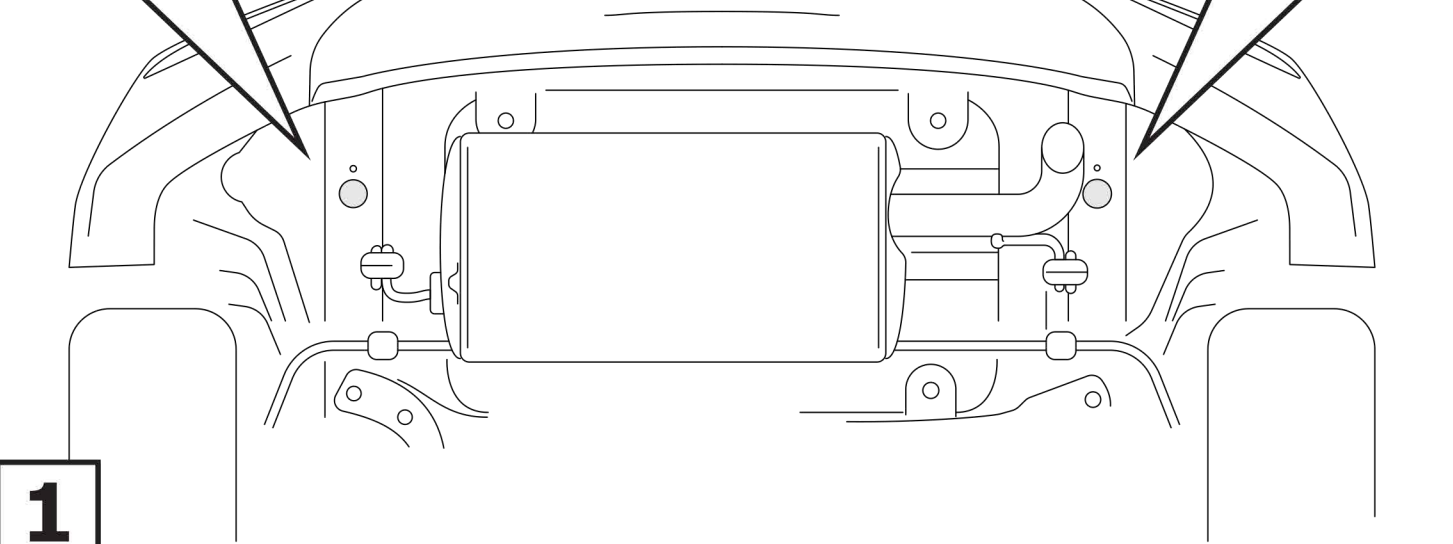
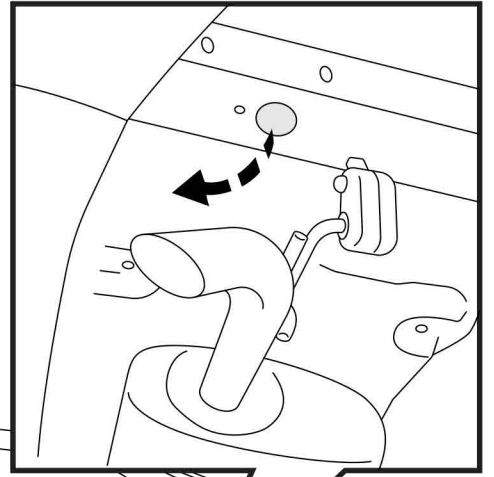
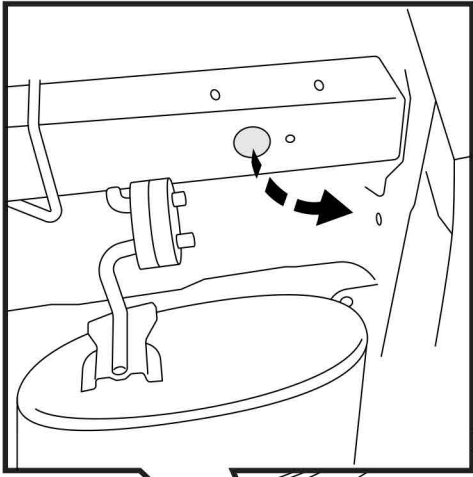

1

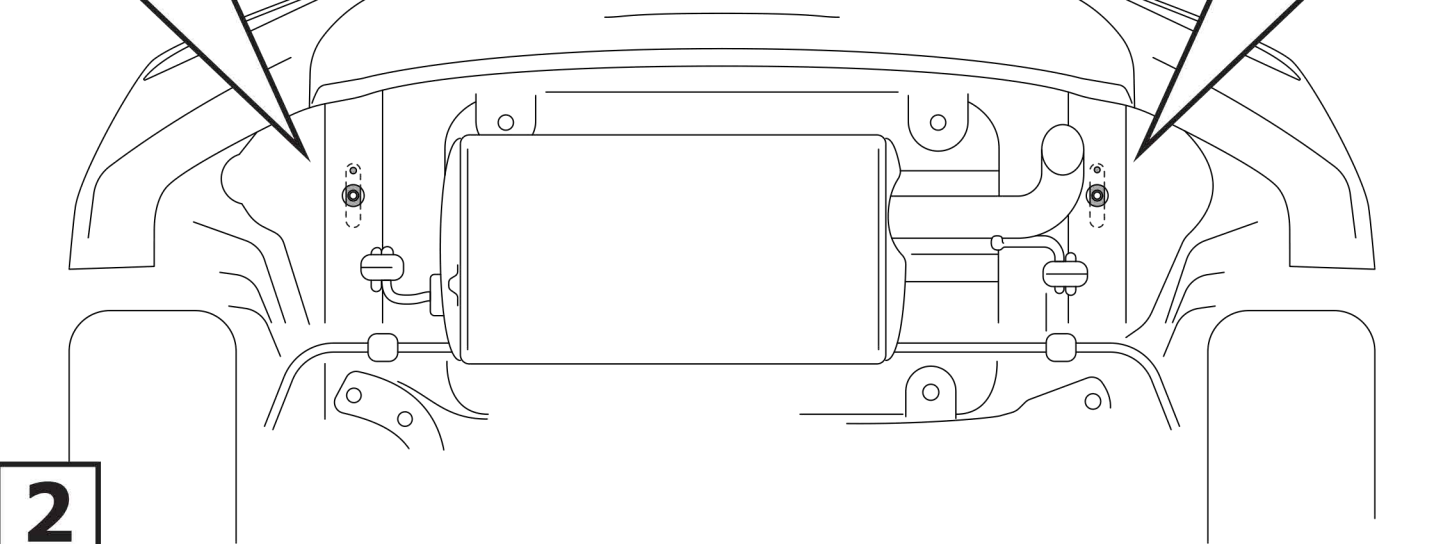
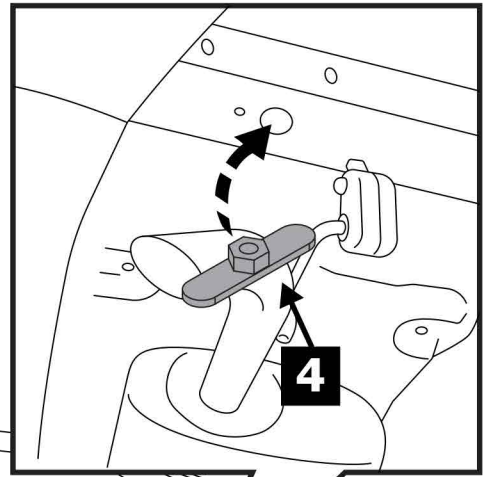
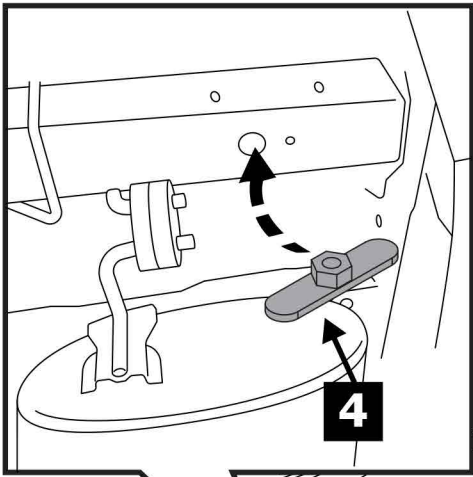

2

